









## ORDERING FORM

**FIXTURE: PH09A PARKER BELLE ANTI-GLARE**

**EXAMPLE: PH09A-R360-150W-80-UNV-4K-EM3-WH-04**

CODE	WATTS & LUMENS	BEAM	VOLTAGE	KELVIN	OPTIONS	FINISH	ACCESSORIES
<b>PH09A-R280</b> Size 11"	<u><b>R280</b></u> 80W-11200L 100W-14000L 120W-16800L 150W-21000L	<b>80</b>	<b>UNV-</b> 100-277V  <b>480V-</b> Special Integral	<b>3K-</b> 3000K <b>4K-</b> 4000K <b>5K-</b> 5000K <b>6K-</b> 6000K	<b>DM-</b> Dimmable <u>Standard</u>  <b>EM2-</b> Emergency Two Hours Integral *Black Finish Only  <b>EM3-</b> Smart Emergency Module Backup Two Hours Integral *White Finish Only  <b>MS-</b> Motion Sensor	<b>WH - White</b> <b>BLK - Black</b>	<b>01-Round Hook</b> <u><b>STANDARD</b></u>
<b>PH09A-R360</b> Size 14"	<u><b>R360</b></u> 100W-14000L 150W-21000L 200W-28000L						<b>02-Bulgin</b> <u><b>STANDARD</b></u>

ACCESSORIES							OPTIONS	
								
01	02	03	04	05	06	07	EM2	EM3

# Parker Belle Anti-Glare PH09A



## Glare-Free LED High Bay Lighting

The Parker Belle Anti-Glare PH09A LED high bay has a honeycomb, patented design which provides an advanced lighting solution to reduce glare, creating a pleasant and comfortable working environment for people. Ideal for office, sports halls, gymnasiums, education, healthcare, municipal, warehouses, shopping malls, etc. Available in 60°-80° beam angles. Attached cord is 6 feet long.

### FEATURES

- 5 Year Warranty
- Dimmable Standard
- Optional Beam Angle
- Excellent Heat Dissipation
- Honeycomb Lens, Low Glare
- 71,000 Hours (L70@Ta 25°C)
- Two Finishes: Black and White
- 480V (Optional) Comes with Internal Driver
- Replaces Traditional High Ceiling Applications
- Two Options Available for Emergency

### APPLICATION

- **INDUSTRIAL**  
Warehouses, Production Halls, Parking Areas
- **EDUCATION**  
Classrooms, Cafeterias, Auditoriums, Gymnasiums
- **SEMI-OUTDOOR**  
Car Garages, Pools, Airports, Train/Bus Stations, Gas Stations, Parks, Toll Stations
- **SHOP & RETAIL**  
Shopping Malls, Supermarkets, Retail Stores
- **ARCHITECTURAL**  
Exhibition Centers, Libraries, Museums, Concert Halls



### SPECIFICATIONS

Model No.	Power (W)	Lumens	lm/W
PH09A-R280	80	11200	140
PH09A-R280	100	14000	140
PH09A-R280	120	16800	140
PH09A-R280	150	21000	140
PH09A-R360	100	14000	140
PH09A-R360	150	21000	140
PH09A-R360	200	28000	140

**Notes:** Above lumens based on 4000K Ra: 80  
 All values in +77°F ambient temperature,  
 luminous flux tolerance +-5%  
 output power tolerance +-5%

### TECHNICAL PRODUCT INFORMATION

**Storage:** -40~+185°F **Operating:** -4~+104°F  
**PF:** ≥0.93 **THD:** ≥20% **Power Efficiency:** ≥0.90  
**Light Source:** SMD3030  
**SDCM:** 3 or 6  
**Certification:** UL  
**Beam Angle:** 80°  
 71,000 Hours (L70@Ta 25°C), 5 Year Warranty  
**CCT Range:** 3000K | 4000K | 5000K | 6000K  
**AC Input:** 100-277V Standard, 50/60Hz, 480V Internal Driver  
**Light Efficiency:** 140 lm/W  
**Waterproof:** IP65 & IK10  
**Recommended Installation Height:** 10 – 65 ½ ft  
**Optional:** Emergency (EM2 and EM3 are integral),  
 Motion Sensor  
**Function:**  Dimmable **Dimming to be 0-10V**

### ACCESSORIES



01



02



03



04



05



06



07

\*07 US Hook to be used only for R360

	IMAGE	PART #	DESIGNATION	MATERIAL	DESCRIPTION	QTY	ACCESSORY USE
<b>Standard</b>	01	PH09-RDHK01	Round Hook	Stainless Steel 304	2" x 1" x 1"	1 PC	Suspension
	02	PH09-BUL02	Bulgin	PC	120 - 277V	1 PC	Grade IP67
<b>Optional</b>	03	PH09-YOKE03	Yoke, R280	GALV Steel	9-3/4 " x 1-5/8 " x 4 "	1 PC	Ceiling Mount
	03	PH09-YOKE03	Yoke R360/R380	GALV Steel	11-1/4 " x 1-5/8 " x 4 "	1 PC	Ceiling Mount
	04	PH09-CHS04	Chain	Stainless Steel	3'	1 PC	Suspension Mount
	05	PH09-CARA05	Carabiner	Stainless Steel	2" x 1" x 3/4"	1 PC	Suspension Mount
	06	PH09-DRVMOD06	Driver Module		277 - 480V	1 PC	277-480V
	07	PH09-USHK07	US Hook	Stainless Steel		1 PC	Suspension



## FEATURES

### TWO INTEGRAL EMERGENCY OPTIONS FOR THE PH09A

Emergency Option if Using Black Finish



Emergency Option if Using White Finish



UGR<22



Unique Heatsink



Beam Angle



## SIZE

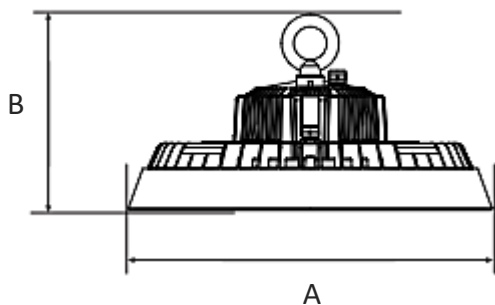

Model No.	Size A (inches)	Size B (inches)
PH09A-R280	11"	7"
PH09A-R360	14"	7 ½"



FEATURES

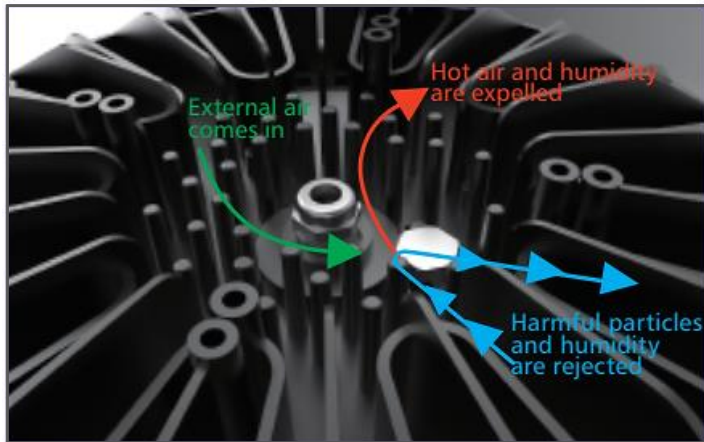

Respirator (Automatically regulates heat dissipation)

Fast Connector

STRUCTURE

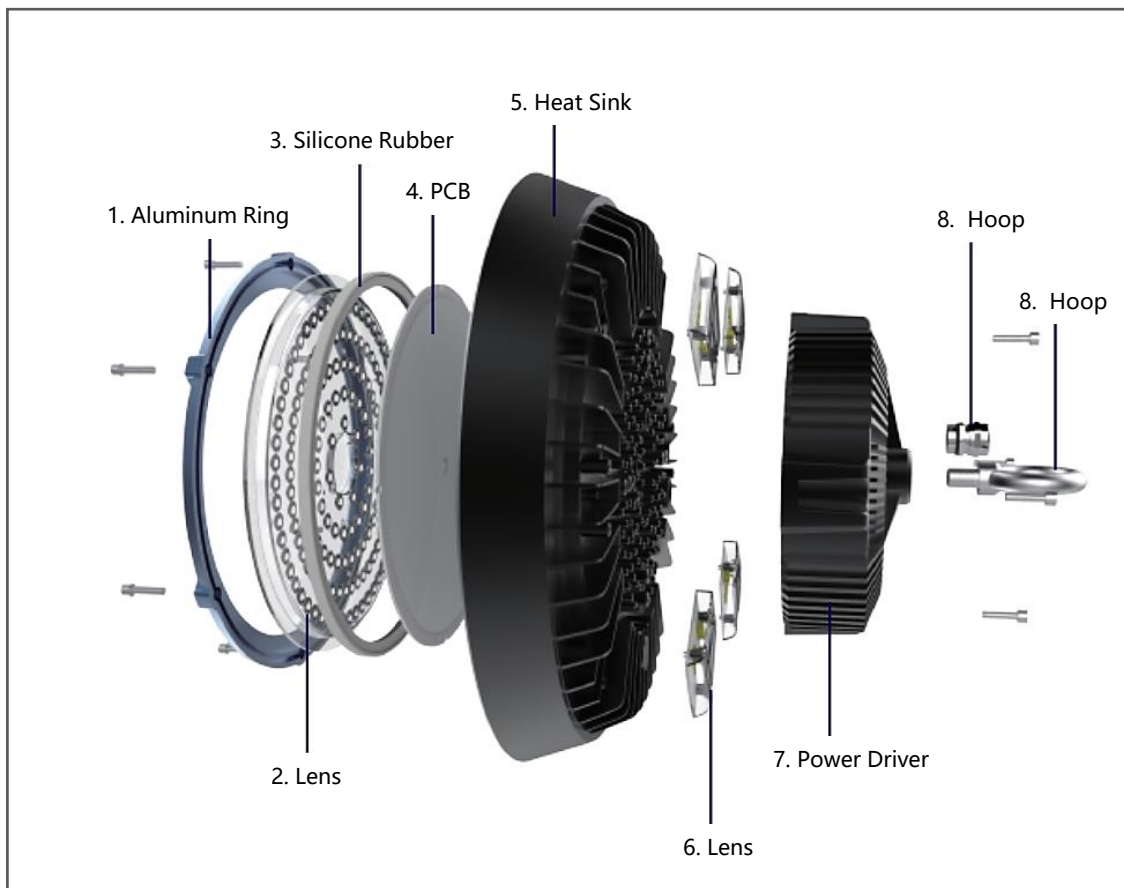



ELECTRONIC

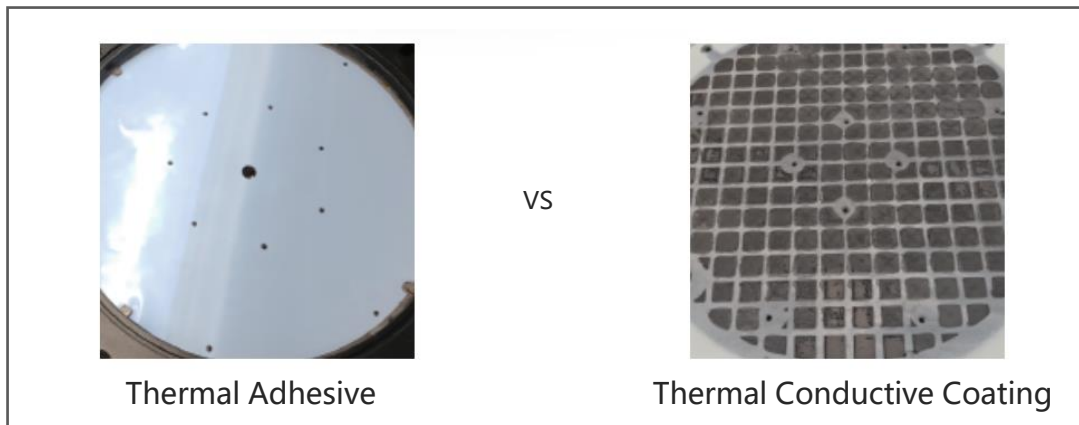
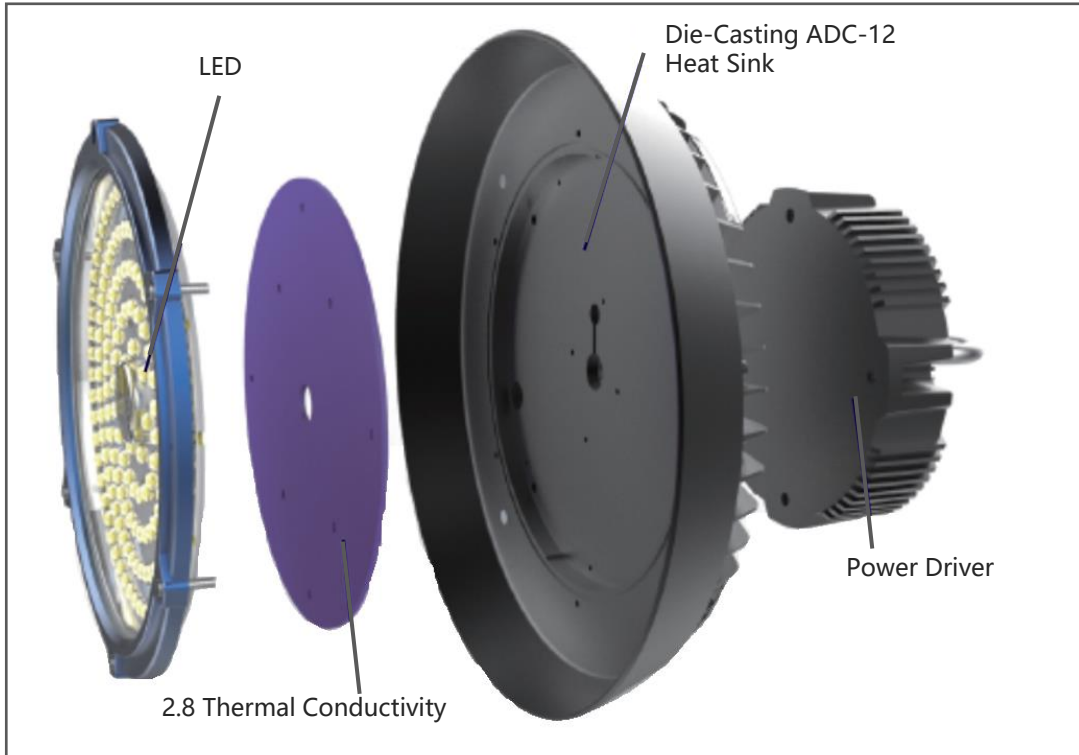

- 1. Superior heat-conducting electronics strengthen the heat-dissipation performance of luminaires.
- 2. Dust-free, no solidification, low attenuation.

